

3

NUOVA LINEATRE



BRUGNOTTO®
SHOP INTERIORS

BRUGNOTTO® SHOP INTERIORS



BRUGNOTTO SHOP INTERIORS produce sistemi di arredi modulari per negozi e spazi espositivi.

L'azienda è stata fondata nel 1980 e ha sede nel nord est d'Italia, a 40 km dalla città di Venezia.

Nei suoi stabilimenti di 18.000 mq, sono presenti le più moderne tecnologie produttive ed operano abili professionisti e designers con grande esperienza nel fashion retail design.

BRUGNOTTO SHOP INTERIORS offre soluzioni di arredo innovativo per nuovi spazi commerciali, grazie anche alla capacità di abbinare più materiali, quali vere pelli selezionate, ecopelle stampata e verniciata, metalli e legni con particolari finiture.

Tutti questi materiali vengono lavorati all'interno dell'azienda con cura e sapienza artigianale rendendo BRUGNOTTO SHOP INTERIORS una realtà unica ed esclusiva.



BRUGNOTTO SHOP INTERIORS produces modular pieces of furniture for shops and show spaces.

The company was founded in 1980 with its headquarters in northeastern Italy, 40 kilometres from Venice.

its headquarters is comprised of 18.000 square metres where the most up-to-date production technology is used by designers and professionals who have a vast experience in modern retail design.



BRUGNOTTO SHOP INTERIORS is able to find innovative furnishing solutions for new commercial spaces thanks to the ability of using different materials, such as carefully chosen genuine leather, printed and varnished eco-leather, various different metals and types of wood with particular finishings.

All these specified materials are used within the company using great care and specialist knowledge making BRUGNOTTO SHOP INTERIORS completely unique and exclusive.

3

NUOVA LINEATRE



LINEA TRE

Questa linea di arredo, con sistema attrezzato della cremagliera, è estremamente funzionale.

I montanti e i pannelli retroilluminati sono elementi di notevole impatto emozionale e garantiscono eleganti soluzioni di visual merchandising, per molteplici settori commerciali.

I banchi cassa, le isole e le composizioni di cassetti sovrapponibili possono essere coordinati all'arredo inserendo elementi rivestiti di ecopelle.

Mensole, appenderie e cassettiere arricchiscono questa linea di arredo modulare.

LINE THREE

With its rack system, this is the most functional line.

Backlighted uprights and panels give an emotional impact and offer elegant solutions of visual merchandising for all types of shops.

All cash counters, islands and drawer units with elements covered in synthetic leather can be easily matched with furniture. This collection offers extra modular furnishing solutions with shelves, hangings and drawer units.



MONTANTI
UPRIGHTS

3M1/N
nobilitato
faced panel
L12 x P10 x H250 cm

3M1/L
nobilitato lucido
glossy faced panel
L12 x P10 x H250 cm

3M1/EP
ecopelle stampa coccodrillo
synthetic croc printed leather
L12 x P10 x H250 cm

3M1/EPL
ecopelle stampa coccodrillo lucido
synthetic croc printed glossy leather
L12 x P10 x H250 cm

3M2/N
retroilluminato nobilitato
back lighted faced panel
L12 x P10 x H250 cm

3M2/L
retroilluminato nobilitato lucido
back lighted glossy faced panel
L12 x P10 x H250 cm

3M2/EP
retroilluminato ecopelle stampa
coccodrillo
back lighted synthetic croc printed
leather
L12 x P10 x H250 cm

3M2/EPL
retroilluminato ecopelle stampa
coccodrillo lucido
back lighted synthetic croc printed
glossy leather
L12 x P10 x H250 cm

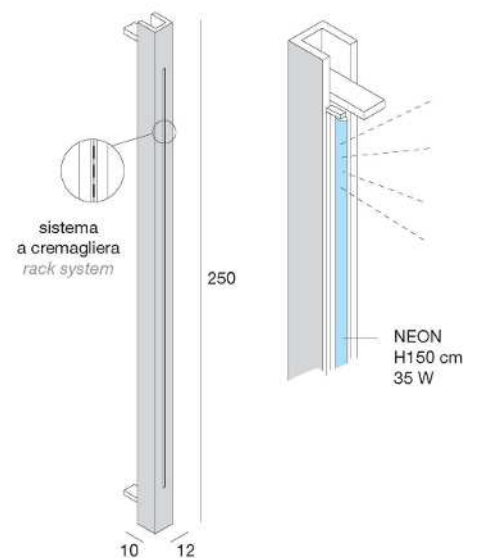



MONTANTI LAMINATO "VERA PIETRA"
LAMINATED UPRIGHTS "TRUE STONE"

3M1/ST

laminato VeraPietra
faceted panel TrueStone
 L12 x P10 x H250 cm

3M2/ST

laminato VeraPietra retroilluminato
faceted panel TrueStone backlighted
 L12 x P10 x H250 cm

DETTAGLI ALLESTIMENTO
FITTING DETAILS

forare e fissare a
 15 cm dal pavimento
*drill and fix
 by 15 cm from floor*

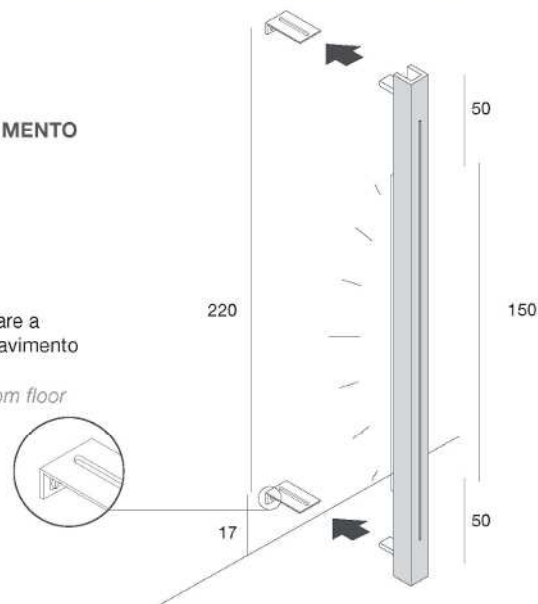



MODULI PARETE "VERA PIETRA"
WALL ELEMENTS "REAL STONE"

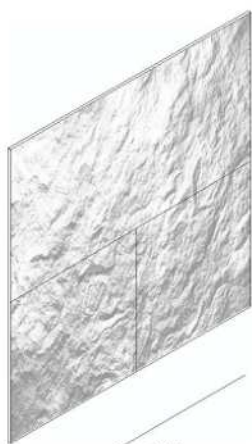

120 cm

3PAN120
 Pannello in laminato "Vera Pietra"
 Wall panel "Real Stone Veneer"
 L. 120 x H. 120 cm

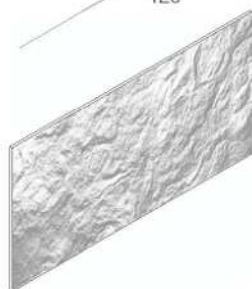

120

60 cm

3PAN60
 Pannello in laminato "Vera Pietra"
 Wall panel "Real Stone Veneer"
 L. 120 x H. 60 cm

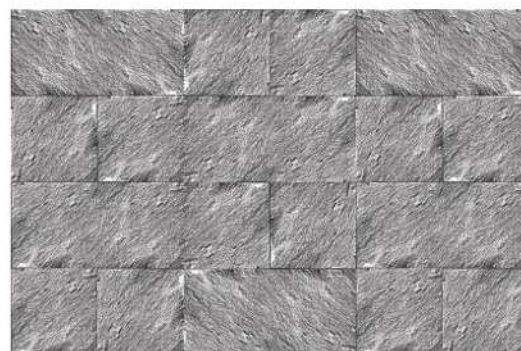

240 cm

120 cm

ESEMPIO TEXTURE A PARETE COMPLETA
COMPLETE WALL TEXTURE EXAMPLE

La naturalità e originalità delle finiture implica un certo grado di irregolarità nelle composizioni, caratteristica del materiale stesso.

The finishing's naturality and originality implies a certain degree of irregularities in the compositions, characteristic of the material itself.

MONTANTI - COMPOSIZIONI
UPRIGHTS - COMPOSITIONS

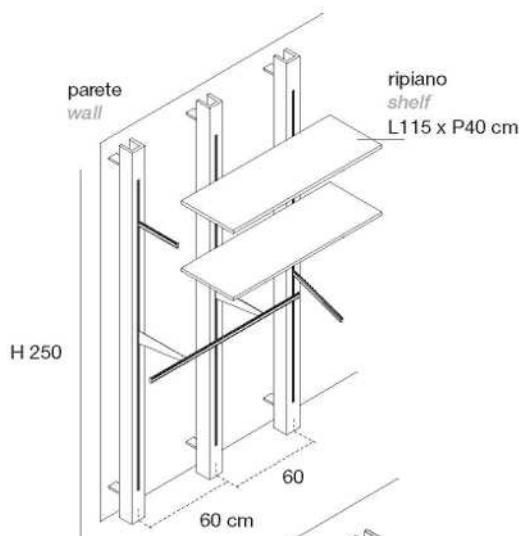

VISTA FRONTALE - *FRONTAL VIEW*

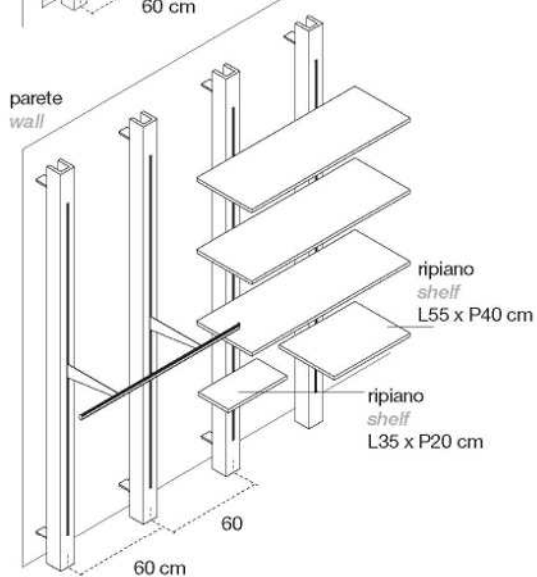
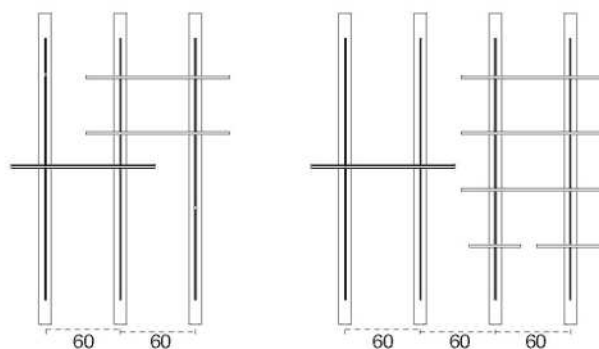

VISTA IN PIANTA - *PLANT VIEW*

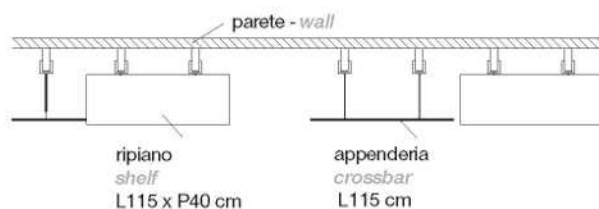



PANNELLI CON CREMAGLIERA
PANELS WITH RACK

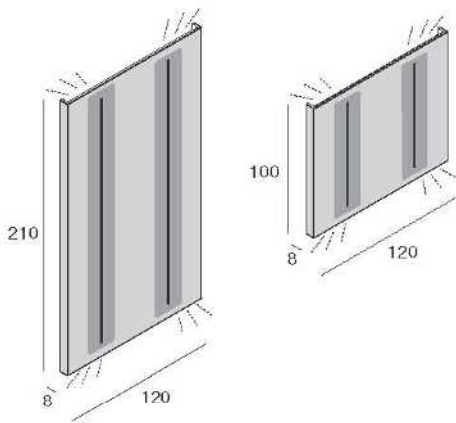

3P1R/NEPIT
retroilluminato in nobilitato
ecopelle stampa coccodrillo
*back lighted in faced panel
synth. croc. printed leather*
L120 x P8 x H210 cm

3P2R/NEPIT
retroilluminato in nobilitato
ecopelle stampa coccodrillo
*back lighted faced panel
synth. croc. printed leather*
L120 x P8 x H100 cm

3P1R/LEPIT
retroilluminato in nobilitato lucido
ecopelle stampa coccodrillo
*back lighted in glossy faced panel
synth. croc. printed leather*
L120 x P8 x H210 cm

3P2R/LEPIT
retroilluminato in nobilitato lucido
ecopelle stampa coccodrillo
*back lighted glossy faced panel
synth. croc. printed leather*
L120 x P8 x H100 cm

3P1R/NEPLIT
retroilluminato in nobilitato
ecopelle st. coccodrillo lucido
*back lighted in faced panel
synth. croc. printed glossy leather*
L120 x P8 x H210 cm

3P2R/NEPLIT
retroilluminato in nobilitato
ecopelle st. coccodrillo lucido
*back lighted faced panel
synth. croc. printed glossy leather*
L120 x P8 x H100 cm

3P1R/LEPLIT
retroilluminato in nobilitato lucido
ecopelle st. coccodrillo lucido
*back lighted in glossy faced panel
synth. croc. printed glossy leather*
L120 x P8 x H210 cm

3P2R/LEPLIT
retroilluminato in nobilitato lucido
ecopelle st. coccodrillo lucido
*back lighted glossy faced panel
synth. croc. printed glossy leather*
L120 x P8 x H100 cm

ACCESSORI
ACCESSORIES

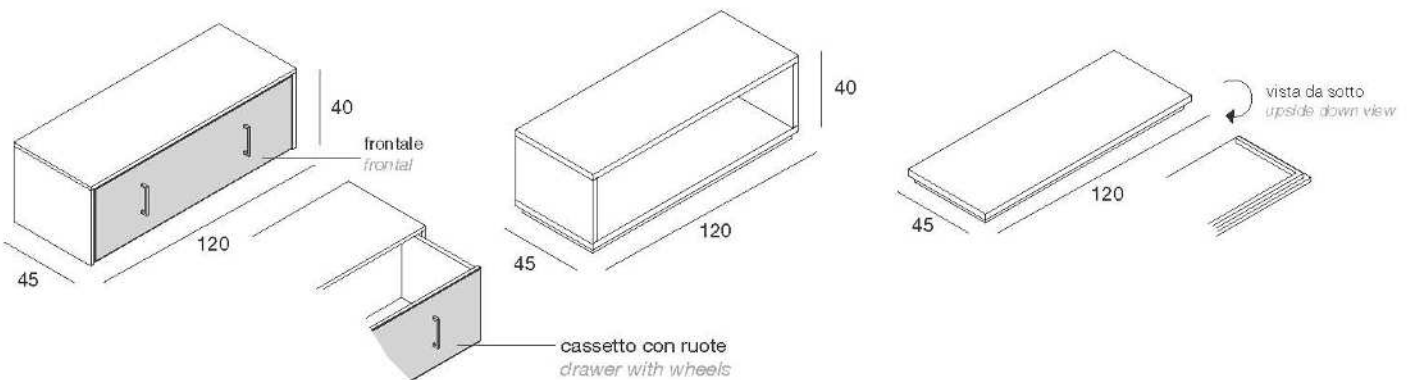

3CA/N
cassettiera
struttura in nobilitato
frontale in nobilitato
*chest of drawers
structure in faced panel
front in faced panel*
L120 x P45 x H40 cm

3CA/EP
cassettiera
struttura in nobilitato
frontale in ecopelle stampa coccodrillo
*chest of drawers
structure in faced panel
front in synthetic croc. printed leather*
L120 x P45 x H40 cm

3A/N
anello
nobilitato
*ring
faced panel*
L120 x P45 x H40 cm

3PE/N
pedana
nobilitato
rialzata con zoccolo
*platform
faced panel
raised with baseboard*
L120 x P45 cm

3CA/L
cassettiera
struttura in nobilitato
frontale in nobilitato lucido
*chest of drawers
structure in faced panel
front in glossy faced panel*
L120 x P45 x H40 cm

3CA/EPL
cassettiera
struttura in nobilitato
frontale in ecopelle stampa
coccodrillo lucido
*chest of drawers
structure in faced panel
front in synthetic croc. printed
glossy leather*
L120 x P45 x H40 cm

3A/L
anello
nobilitato lucido
*ring
glossy faced panel*
L120 x P45 x H40 cm

3PE/L
pedana
nobilitato lucido
rialzata con zoccolo
*platform
glossy faced panel
raised with baseboard*
L120 x P45 cm



PANNELLI CON CREMAGLIERA
PANELS WITH RACK

3P1/N
 nobilitato
faced panel
 L120 x H250 cm

3P1/L
 nobilitato lucido
glossy faced panel
 L120 x H250 cm

3P1/EP
 ecopelle stampa coccodrillo
synth. croc printed leather
 L120 x H250 cm

3P1/EPL
 ecopelle st. coccodrillo lucido
synth. croc printed glossy leather
 L120 x H250 cm

3P2/N
 nobilitato
faced panel
 L120 x H100 cm

3P2/L
 nobilitato lucido
glossy faced panel
 L120 x H100 cm

3P2/EP
 ecopelle stampa coccodrillo
synth. croc printed leather
 L120 x H100 cm

3P2/EPL
 ecopelle st. coccodrillo lucido
synth. croc printed glossy leather
 L120 x H100 cm

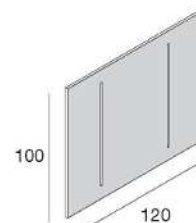
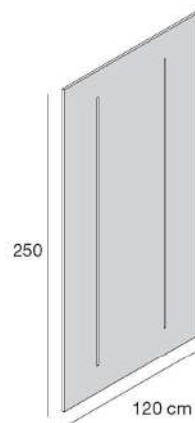



PANNELLI CON CREMAGLIERA RETROILLUMINATI
BACKLIGHTED PANELS WITH RACK

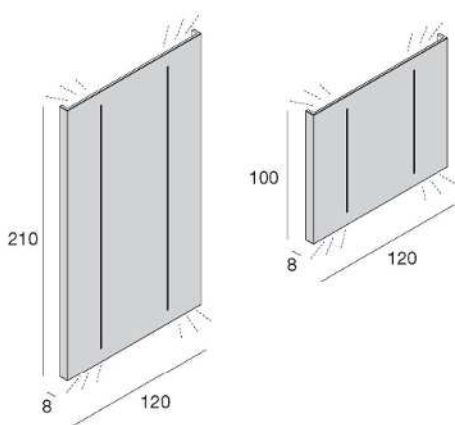

3P1R/N

retroilluminato
 nobilitato
back lighted
faced panel
 L120 x P8 x H210 cm

3P1R/L

retroilluminato
 nobilitato lucido
back lighted
glossy faced panel
 L120 x P8 x H210 cm

3P1R/EP

retroilluminato
 ecopelle stampa coccodrillo
back lighted
synth. croc printed leather
 L120 x P8 x H210 cm

3P1R/EPL

retroilluminato
 ecopelle st. coccodrillo lucido
back lighted
synth. croc printed glossy leather
 L120 x P8 x H210 cm

3P2R/N

retroilluminato
 nobilitato
back lighted
faced panel
 L120 x P8 x H100 cm

3P2R/L

retroilluminato
 nobilitato lucido
back lighted
glossy faced panel
 L120 x P8 x H100 cm

3P2R/EP

retroilluminato
 ecopelle stampa coccodrillo
back lighted
synth. croc printed leather
 L120 x P8 x H100 cm

3P2R/EPL

retroilluminato
 ecopelle st. coccodrillo lucido
back lighted
synth. croc printed glossy leather
 L120 x P8 x H100 cm



MODULI SOVRAPPONIBILI
SUPERIMPOSABLE MODULES

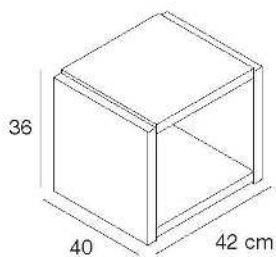

3C/N
 cubo
 nobilitato
 cube
 faced panel
 L42 x P40 x H36 cm

3CAS/N
 cassetto
 struttura in nobilitato
 frontale in nobilitato
 drawer
 structure in faced panel
 front in faced panel
 L35 x P37 x H27 cm

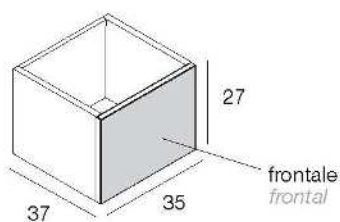

3CAS/L
 cassetto - struttura in nobilitato
 frontale in nobilitato lucido
 drawer - structure in faced panel
 front in glossy faced panel
 L35 x P37 x H27 cm

3CAS/EP
 cassetto
 struttura in nobilitato
 frontale in ecopelle stampa coccodrillo
 drawer
 structure in faced panel
 front in synthetic croc printed leather
 L35 x P37 x H27 cm

3CAS/EPL
 cassetto - struttura in nobilitato
 frontale in ecopelle stampa coccodrillo lucido
 drawer - structure in faced panel
 front in synthetic croc printed glossy leather
 L35 x P37 x H27 cm

3CAS/ST
 cassetto
 struttura in nobilitato
 frontale in laminato Vera Pietra
 drawer structure in faced panel
 front in True Stone faced panel
 L35 x P37 x H27 cm

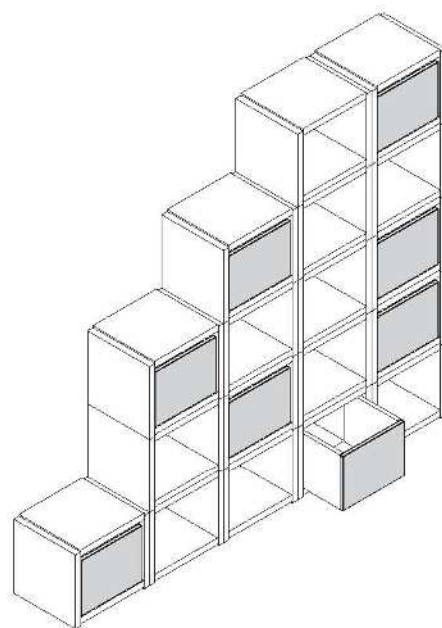



BANCHI CASSA
CASH COUNTERS

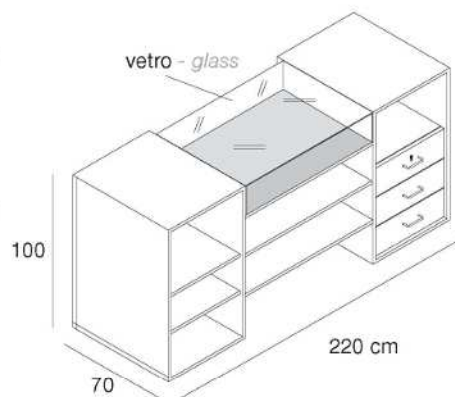
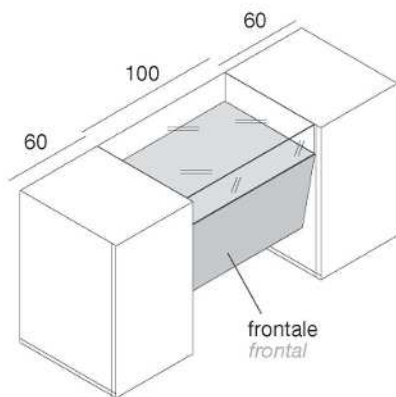

3BC1/N
struttura in nobilitato
frontale in nobilitato
structure in faced panel
front in faced panel
L220 x P70 x H100 cm

3BC1/L
struttura in nobilitato
frontale in nobilitato lucido
structure in faced panel
front in glossy faced panel
L220 x P70 x H100 cm

3BC1/EP
struttura in nobilitato
frontale in ecopelle stampa coccodrillo
structure in faced panel
front in synthetic croc printed leather
L220 x P70 x H100 cm

3BC1/EPL
struttura in nobilitato
frontale in ecopelle stampa coccodrillo lucido
structure in faced panel
front in synthetic croc printed glossy leather
L220 x P70 x H100 cm

3BC1/ST
struttura in nobilitato
frontale in laminato Vera Pietra
structure in faced panel
front in True Stone faced panel
L220 x P70 x H100 cm



ISOLA AUTOPORTANTE
FREESTANDING RACK ISLAND

3IS/N

base e struttura in nobilitato
frontali in nobilitato
*base and structure in faced panel
fronts in faced panel*
L120 x P90 x H160 cm

3IS/L

base e struttura in nobilitato
frontali in nobilitato lucido
*base and structure in faced panel
fronts in glossy faced panel*
L120 x P90 x H160 cm

3IS/EP

base e struttura in nobilitato
frontali in ecopelle stampa coccodrillo
*base and structure in faced panel
fronts in synthetic croc printed leather*
L120 x P90 x H160 cm

3IS/EPL

base e struttura in nobilitato
frontali in ecopelle stampa coccodrillo lucido
*base and structure in faced panel
fronts in synthetic croc printed glossy leather*
L120 x P90 x H160 cm

3TO/N

nobilitato
faced panel
L60 x P60 x H150

3TO/L

nobilitato lucido
glossy faced panel
L60 x P60 x H150

3TO/EP

150
ecopelle stampa coccodrillo
synth. croc printed leather
L60 x P60 x H150

3TO/EPL

ecopelle stampa coccodrillo
lucida
synth. croc printed glossy leather
L60 x P60 x H150

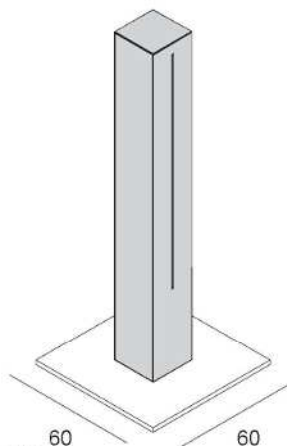
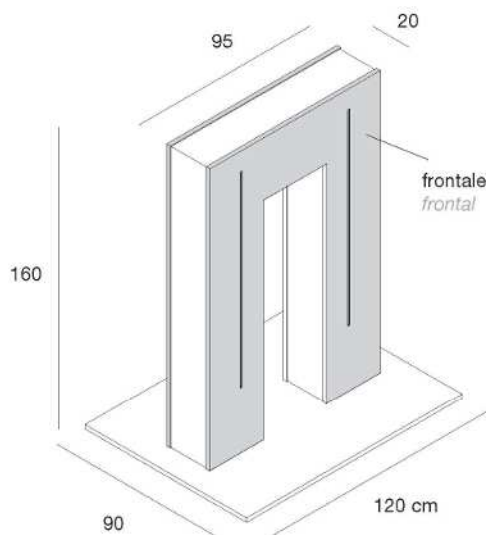



BANCHI CASSA
CASH COUNTERS

SMALL

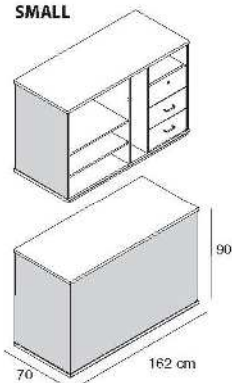

LARGE

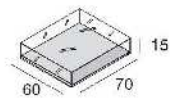
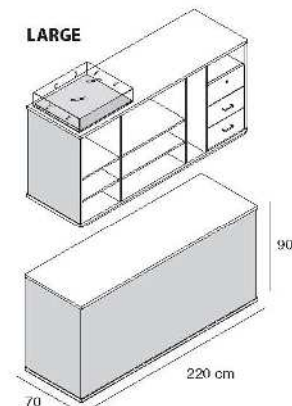

3BC2/N

banco cassa small
struttura in nobilitato
frontale e laterali in nobilitato
*small cash counter
structure in faced panel
front and laterals in faced panel*
L162 x P70 x H90 cm

3BC2/L

banco cassa small
struttura in nobilitato
frontale e laterali in nobilitato lucido
*small cash counter
structure in faced panel
front and laterals in glossy
faced panel*
L162 x P70 x H90 cm

3BC2/ST

banco cassa small
struttura in nobilitato
frontale e laterali in laminato
Vera Pietra
*small cash counter
structure in faced panel
front and laterals in Real Stone
faced panels*
L162 x P70 x H90 cm

3BC2/EP

banco cassa small
struttura in nobilitato
frontale e laterali in ecopelle
stampa coccodrillo
*small cash counter
structure in faced panel
front and laterals in synthetic
croc printed leather*
L162 x P70 x H90 cm

3BC2/EPL

banco cassa small
struttura in nobilitato
frontale e laterali in ecopelle
st. coccodrillo lucido
*small cash counter
structure in faced panel
front and laterals in synth.
croc printed glossy leather*
L162 x P70 x H90 cm

3BC3/N

banco cassa large
struttura in nobilitato
frontale e laterali in nobilitato
*large cash counter
structure in faced panel
front and laterals in faced panel*
L220 x P70 x H90 cm

3BC3/L

banco cassa large
struttura in nobilitato
frontale e laterali in nobilitato lucido
*large cash counter
structure in faced panel
front and laterals in glossy
faced panel*
L220 x P70 x H90 cm

3BC3/ST

banco cassa small
struttura in nobilitato
frontale e laterali in laminato
Vera Pietra
*small cash counter
structure in faced panel
front and laterals in Real Stone
faced panels*
L220 x P70 x H90 cm

3TC/N

teca vetro
base in nobilitato
*glass case
base in faced panel*

3TC/L

teca vetro
base in nobilitato lucido
*glass case
base in glossy faced panel*

3TC/EP

teca vetro
base in ecopelle stampa coccodrillo
*glass case
base in synthetic croc printed leather*

3TC/EPL

teca vetro
base in ecopelle stampa coccodrillo lucido
*glass case
base in synthetic croc printed glossy leather*

3BC3/EP

banco cassa large
struttura in nobilitato
frontale e laterali in ecopelle
stampa coccodrillo
*large cash counter
structure in faced panel
front and laterals in synthetic
croc printed leather*
L220 x P70 x H90 cm

3BC3/EPL

banco cassa large
struttura in nobilitato
frontale e laterali in ecopelle
st. coccodrillo lucido
*large cash counter
structure in faced panel
front and laterals in synth.
croc printed glossy leather*
L220 x P70 x H90 cm



TAVOLI
TABLES

LARGE

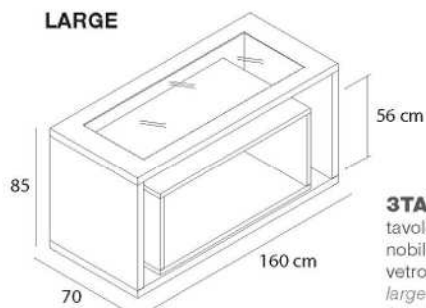

3TAVL/N
tavolo large
nobilitato
vetro ad incastro
*large table
faced panel
recessed glass*
L160 x P70 x H85 cm

vano estraibile
pull-out compartment
L120 x P60 x H56 cm

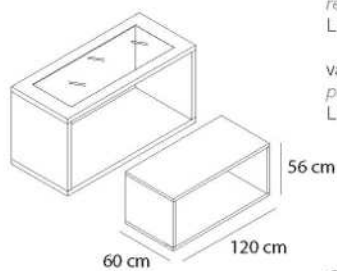

3TAVL/L
tavolo large
nobilitato lucido
vetro ad incastro
*large table
glossy faced panel
recessed glass*
L160 x P70 x H85 cm

vano estraibile
pull-out compartment
L120 x P60 x H56 cm

SMALL

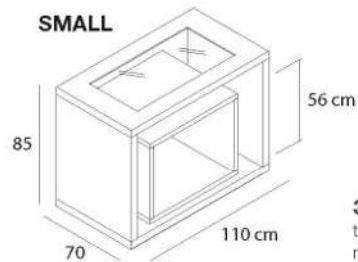

3TAVS/N
tavolo small
nobilitato
vetro ad incastro
*small table
faced panel
recessed glass*
L110 x P70 x H85 cm

vano estraibile
pull-out compartment
L70 x P50 x H56 cm

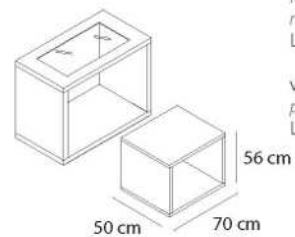

3TAVS/L
tavolo small
nobilitato lucido
vetro ad incastro
*small table
glossy faced panel
recessed glass*
L110 x P70 x H85 cm

vano estraibile
pull-out compartment
L70 x P50 x H56 cm



**TAVOLI
TABLES**

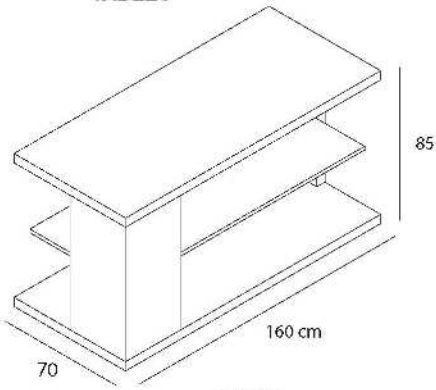

3TA/N
tavolo
nobilitato
table
faced panel
L160 x P70 x H85 cm

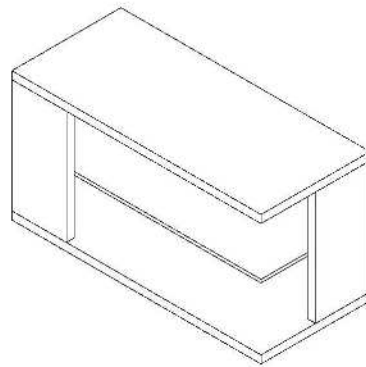

3TA/L
tavolo
nobilitato lucido
table
glossy faced panel
L160 x P70 x H85 cm

**MODULO RETRO CASSA
BACK-CASH MODULE**

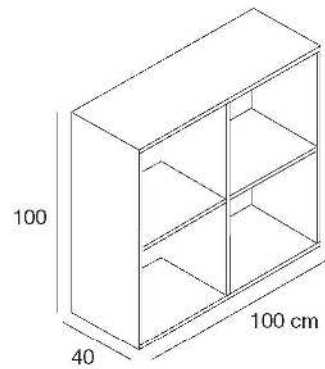

3RC/N
nobilitato
faced panel
L100 x P40 x H100 cm

3RC/NL
nobilitato lucido
glossy faced panel
L100 x P40 x H100 cm





CAMERINO
CHANGING ROOM

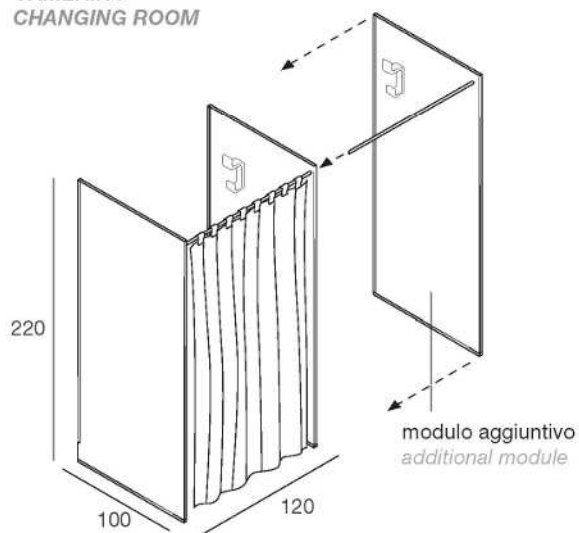

3CAM1/N
camerino
tubo tenda
coppia ganci appendini
coppia pannelli nobilitato
changing room
tube for curtain
pair of wall clothes hangers
pair of faced panels
L120 x P100 x H220 cm

3CAM2/N
modulo aggiuntivo
tubo tenda
coppia ganci appendini
pannello nobilitato
additional module
tube for curtain
pair of wall clothes hangers
faced panel
L120 x H220 cm

3TEV
tenda
curtain
L140 x H200 cm

3MRR/N
specchio
cornice in nobilitato
mirror
frame in faced panel
L85 x H205 cm

3MRR/L
specchio
cornice in nobilitato lucido
mirror frame in
glossy faced panel
L85 x H205 cm

3MRR/EP
specchio
cornice ecopelle st. coccodrillo
mirror
frame in synth. croc printed
leather
L85 x H205 cm

3MRR/EPL
specchio
cornice ecopelle st. coccodrillo
lucido
mirror
frame in synth. croc printed
glossy leather
L85 x H205 cm

3GA
gancio appenderia
alluminio
clothes hanger
aluminium
P15 x H10 cm

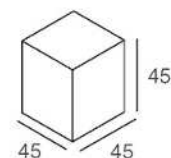

3POU/EP
pouf rivestito
ecopelle stampa coccodrillo
padded pouf
synth. croc printed leather
L45 x P45 x H45 cm

3POU/EPL
pouf rivestito
ecopelle stampa coccodrillo lucido
padded pouf
synth. croc printed glossy leather
L45 x P45 x H45 cm

ACCESSORI
ACCESSORIES

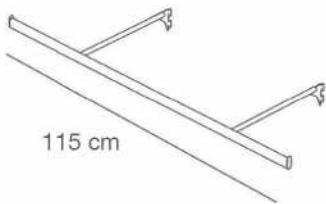

3BAP
Barra appenderia
initura cromo opaco
*Hanging bar
matt chromium finishing*
L.115 cm

3APF
Appenderia frontale dritta
finitura cromo opaco
*Straight frontal crossbar
matt chromium finishing*
L.30 cm

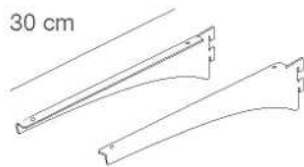

3RM/L
Coppia staffe reggimensola
per legno finitura cromo opaco
*Pair of shelves holder
for wood matt chromium
finishing*
L.30 cm

3APFZ
Appenderia frontale inclinata
finitura cromo opaco
*Tilted frontal crossbar
matt chromium finishing*
L.38 cm

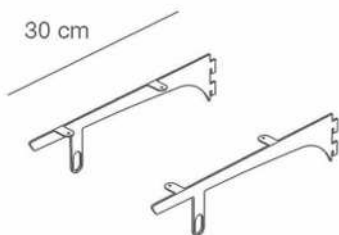
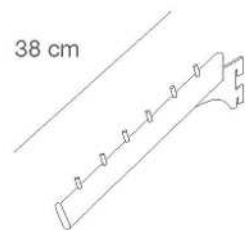

3MEBAP/L
Coppia staffe reggimensola legno
e barra appenderia finitura cromo opaco
*Pair of wood shelves holders with
hanging bar matt chromium finishing*

3BAP2
Barra appenderia piccola
finitura cromo opaco
*Straight frontal crossbar
matt chromium finishing*
L.40 x P. 30 cm

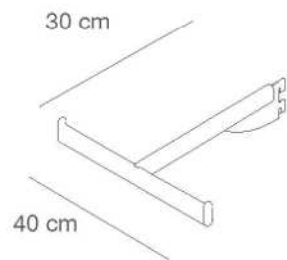

3RMM/L
Staffa singola per mensola media
e piccola in legno finitura cromo opaco
*Pair of shelves holder for wood
matt chromium finishing*
L.20 cm

3RT
Supporto reggitubo per tubo ovale 30 x 15 mm
finitura cromo opaco
*Holder for oval tube 30 x 15 mm
matt chromium finishing*

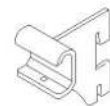

3TUB
Tubo ovale 30 x 15 mm e tappi chiusura,
disponibile misure a richiesta finitura cromo opaco
*Oval tube 30 x 15 mm and closing caps,
length available on request, matt chromium finishing.*

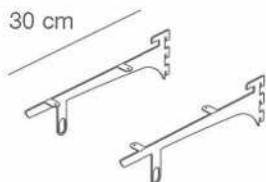
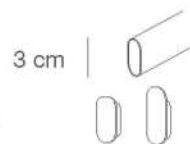

3MEBAP/V
Coppia staffe reggimensola vetro sp.8mm
e barra appenderia finitura cromo opaco
*Pair of glass th.8mm shelves holders
with hanging bar matt chromium finishing*

3BLIST
Portablister per tubo ovale 30 x 15 mm
finitura cromo opaco
*Blisterholder for oval tube 30 x 15 mm
matt chromium finishing*
L.20 cm

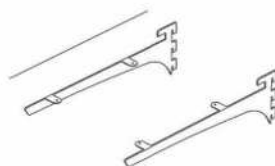

3ME/V
Coppia staffe reggimensola vetro sp.8mm
finitura cromo opaco
*Pair of glass th.8mm shelvesholders
matt chromium finishing*

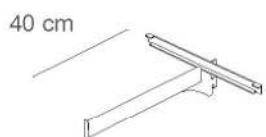

3RMM/V
Reggimensola media per vetro sp.8mm
finitura cromo opaco
*Medium shelves holder for glass th.8mm
matt chromium finishing*
L.30 cm

3RMS/V 2
Reggimensola piccola per vetro sp.8mm
finitura cromo opaco
*Small shelves holder for glass th.8mm
matt chromium finishing*

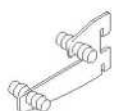

3RMS/V
Reggimensola piccola per vetro sp.8mm
finitura cromo opaco
*Small shelves holder for glass th.8mm
matt chromium finishing*

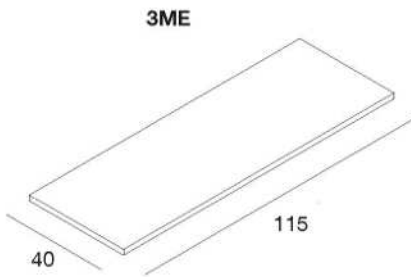

3ME/L

mensola in nobilitato lucido
shelf in glossy faced panel
L115 x P40 cm – sp 18 mm

3ME/N

mensola in nobilitato
shelf in faced panel
L115 x P40 cm – sp 18 mm

3ME/ST

mensola in nobilitato
shelf in faced panel
L115 x P40 cm – sp 18 mm

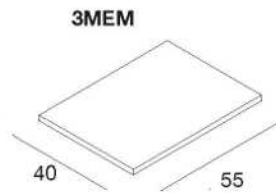

3MEM/L

mensola in nobilitato lucido
shelf in glossy faced panel
L55 x P40 cm – sp 18 mm

3MEM/N

mensola in nobilitato
shelf in faced panel
L55 x P40 cm – sp 18 mm

3MEM/ST

mensola in nobilitato
shelf in faced panel
L55 x P40 cm – sp 18 mm

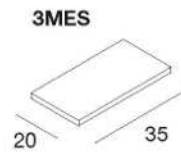

3MES/L

mensola in nobilitato lucido
shelf in glossy faced panel
L35 x P20 cm – sp 18 mm

3MES/N

mensola in nobilitato
shelf in faced panel
L35 x P20 cm – sp 18 mm

3MES/ST

mensola in nobilitato
shelf in faced panel
L35 x P20 cm – sp 18 mm

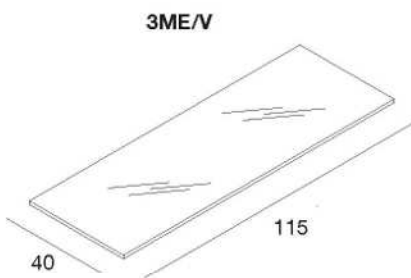

3ME/V

mensola in vetro temperato
shelf in tempered glass
L115 x P40 cm – sp 8 mm

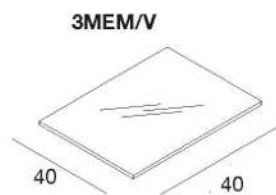

3MEM/V

mensola in vetro temperato
shelf in tempered glass
L40 x P40 cm – sp 8 mm

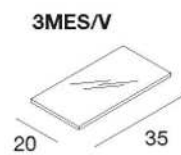

3MES/V

mensola in vetro temperato
shelf in tempered glass
L35 x P20 cm – sp 8 mm



NOBILITATI
FACED PANELS



NERO LUCIDO
GLOSSY BLACK



BIANCO LUCIDO
GLOSSY WHITE



NERO
BLACK



BIANCO
WHITE



ABETE NODATO
KNOTTED FIR



ABETE VISSUTO BIANCO
WHITE VINTAGE FIR



ROVERE TAVOLATO
PLANKED OAK



ABETE GESSATO
CHALKY FIR



EBANO PRECOMPOSTO
EBONY VENEERED PLYWOOD



WENGE'
WENGE'



ROVERE AMERICANO
AMERICAN OAK



LAMIERA OSSIDATA
OXIDIZED SHEET

FINITURE E MATERIALI "VERA PIETRA"
FINISHINGS AND MATERIALS "REAL STONE"



ARGENTO



COBRE NEW



AURO



D_BLACK

FINITURE TESSUTI
FABRIC FINISHINGS



VELLUTO BEIGE
VELVET BEIGE



VELLUTO ROSSO
VELVET RED



VELLUTO NERO
VELVET BLACK



TAFTA' CRINKLE NEWCREAM
TAFTA' CRINKLE NEWCREAM



TAFTA' CRINKLE GRIGIO
TAFTA' CRINKLE GREY



TAFTA' CRINKLE BORDEAUX
TAFTA' CRINKLE BORDEAUX



TAFTA' CRINKLE GREEN
TAFTA' CRINKLE GREEN

ECOPELLE STAMPA COCCODRILLO
SYNTHETIC CROC PRINTED LEATHER



BIANCO
WHITE



BEIGE
BEIGE



CASTAGNO
CHESTNUT



NERO
BLACK

ECOPELLE STAMPA COCCODRILLO LUCIDO
SYNTHETIC CROC PRINTED GLOSSY LEATHER



AVORIO
IVORY

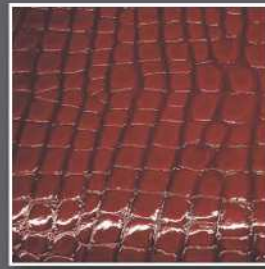

ROSSO RUBINO
RUBY RED



TESTA DI MORO
DARK BROWN

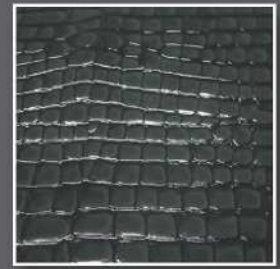

GRIGIO
GREY

ACCESSORI
ACCESSORIES



CROMO OPACO
CHROMIUM MATT



VETRO TEMPERATO
CLEAR GLASS

| CODICE <i>CODE</i> | DESCRIZIONE <i>DESCRIPTION</i> | PREZZO <i>PRICE</i> | PAG. <i>PAGE</i> |
|--|---|-------------------------------|----------------------------|
| MONTANTI <i>UPRIGHTS</i> | | | |
| 3M1/N | Montante con cremagliera in nobilitato opaco. L.12xP.10 H.250cm <i>Upright with rack in matt chipboard. L.12xP.10 H.250cm</i> | € 260,00 | 2 |
| 3M1/L | Montante con cremagliera in nobilitato verniciato lucido (BIANCO/NERO). L.12xP.10 H.250cm <i>Upright with rack in glossy chipboard (WHITE/BLACK). L.12xP.10 H.250cm</i> | € 311,00 | 2 |
| 3M1/EP | Montante con cremagliera rivestito in Eco-pelle opaca. L.12xP.10 H.250cm <i>Upright with rack covered with synthetic matt leather. L.12xP.10 H.250cm</i> | € 320,00 | 2 |
| 3M1/EPL | Montante con cremagliera rivestito in Eco-pelle lucida. L.12xP.10 H.250cm <i>Upright with rack covered with synthetic glossy leather. L.12xP.10 H.250cm</i> | € 351,00 | 2 |
| 3M1/ST | Montante con cremagliera in laminato di vera pietra. L.12xP.10 H.250cm <i>Upright with rack in real stone veneer. L.12xP.10 H.250cm</i> | € 430,00 | 3 |
| MONTANTI RETROILLUMINATI <i>BACKLIGHTED UPRIGHTS</i> | | | |
| 3M2/N | Montante retroilluminato con cremagliera in nobilitato opaco. L.12xP.10 H.250cm <i>Back-lighted upright with rack in matt chipboard. L.12xP.10 H.250cm</i> | € 310,00 | 2 |
| 3M2/L | Montante retroilluminato con cremagliera in nobilitato verniciato lucido (BIANCO/NERO). L.12xP.10 H.250cm <i>Back-lighted upright with rack in glossy chipboard (WHITE/BLACK). L.12xP.10 H.250cm</i> | € 361,00 | 2 |
| 3M2/EP | Montante retroilluminato con cremagliera rivestito in Eco-pelle opaca. L.12xP.10 H.250cm <i>Back-lighted upright with rack covered with synthetic matt leather. L.12xP.10 H.250cm</i> | € 370,00 | 2 |
| 3M2/EPL | Montante retroilluminato con cremagliera rivestito in Eco-pelle lucida. L.12xP.10 H.250cm <i>Back-lighted upright with rack covered with synthetic glossy leather. L.12xP.10 H.250cm</i> | € 401,00 | 2 |
| 3M2/ST | Montante retroilluminato con cremagliera in laminato di vera pietra. L.12xP.10 H.250cm <i>Back-lighted upright with rack in real stone veneer. L.12xP.10 H.250cm</i> | € 480,00 | 3 |

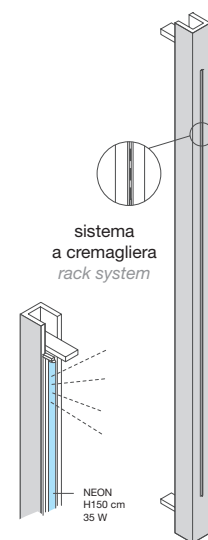
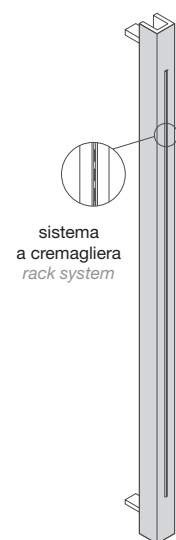

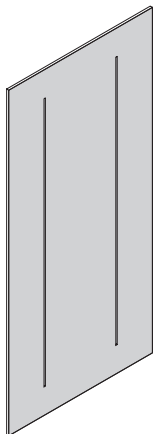
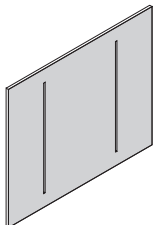
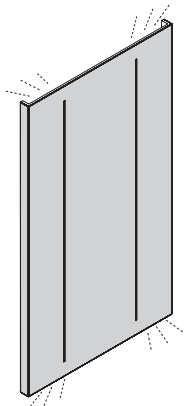
| CODICE <i>CODE</i> | DESCRIZIONE <i>DESCRIPTION</i> | PREZZO <i>PRICE</i> | PAG. <i>PAGE</i> | |
|---|---|-------------------------------|----------------------------|---|
| PANNELLI CON CREMAGLIERA <i>PANELS WITH RACKS</i> | | | | |
| 3P1/N | Pannello in nobilitato opaco. L120 H.250cm <i>Panel in matt chipboard. L120 H.250cm</i> | € 328,00 | 8 |  |
| 3P1/L | Pannello in nobilitato verniciato lucido (BIANCO/NERO). L120 H.250cm <i>Panel in glossy chipboard (WHITE/BLACK). L120 H.250cm</i> | € 425,00 | 8 | |
| 3P1/EP | Pannello rivestito in Eco-pelle opaca. L120 H.250cm <i>Panel covered with synthetic matt leather. L120 H.250cm</i> | € 565,00 | 8 | |
| 3P1/EPL | Pannello rivestito in Eco-pelle lucida. L120 H.250cm <i>Panel covered with synthetic glossy leather. L120 H.250cm</i> | € 597,00 | 8 | |
| PANNELLI CON CREMAGLIERA RETROILLUMINATI <i>BACKLIGHTED PANELS WITH RACKS</i> | | | | |
| 3P2/N | Pannello in nobilitato opaco. L120 H.100cm <i>Panel in matt chipboard. L120 H.100cm</i> | € 190,00 | 8 |  |
| 3P2/L | Pannello in nobilitato verniciato lucido (BIANCO/NERO). L120 H.100cm <i>Panel in glossy chipboard (WHITE/BLACK). L120 H.100cm</i> | € 225,00 | 8 | |
| 3P2/EP | Pannello rivestito in Eco-pelle opaca. L120 H.100cm <i>Panel covered with synthetic matt leather. L120 H.100cm</i> | € 299,00 | 8 | |
| 3P2/EPL | Pannello rivestito in Eco-pelle lucida. L120 H.100cm <i>Panel covered with synthetic glossy leather. L120 H.100cm</i> | € 315,00 | 8 | |
| 3P1R/N | Pannello retroilluminato in nobilitato opaco. L.120xP.8 H.210cm <i>Back-lighted panel in matt chipboard. L.120xP.8 H.210cm</i> | € 495,00 | 9 |  |
| 3P1R/L | Pannello retroilluminato in nobilitato verniciato lucido (BIANCO/NERO). L.120xP.8 H.210cm <i>Back-lighted panel in glossy chipboard (WHITE/BLACK). L.120xP.8 H.210cm</i> | € 545,00 | 9 | |
| 3P1R/EP | Pannello retroilluminato rivestito in Eco-pelle opaca. L.120xP.8 H.210cm <i>Back-lighted panel covered with synthetic matt leather. L.120xP.8 H.210cm</i> | € 695,00 | 9 | |
| 3P1R/EPL | Pannello retroilluminato rivestito in Eco-pelle lucida. L.120xP.8 H.210cm <i>Back-lighted panel covered with synthetic glossy leather. L.120xP.8 H.210cm</i> | € 740,00 | 9 | |
| 3P2R/N | Pannello retroilluminato in nobilitato opaco. L.120xP.8 H.100cm <i>Back-lighted panel in matt chipboard. L.120xP.8 H.100cm</i> | € 340,00 | 9 | |

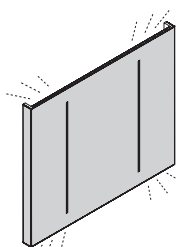
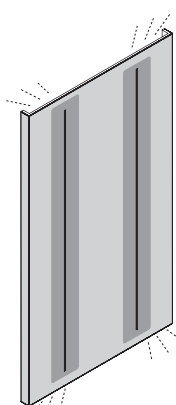
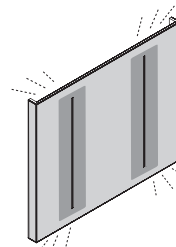
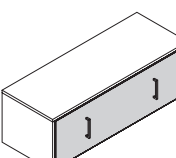
| CODICE <i>CODE</i> | DESCRIZIONE <i>DESCRIPTION</i> | PREZZO <i>PRICE</i> | PAG. <i>PAGE</i> | |
|---|--|-------------------------------|----------------------------|---|
| 3P2R/L | Pannello retroilluminato in nobilitato verniciato lucido (BIANCO/NERO). L.120xP.8 H.100cm <i>Back-lighted panel in glossy chipboard (WHITE/BLACK). L.120xP.8 H.100cm</i> | € 390,00 | 9 |  |
| 3P2R/EP | Pannello retroilluminato rivestito in Eco-pelle opaca. L.120xP.8 H.100cm <i>Back-lighted panel covered with synthetic matt leather. L.120xP.8 H.100cm</i> | € 490,00 | 9 | |
| 3P2R/EPL | Pannello retroilluminato rivestito in Eco-pelle lucida. L.120xP.8 H.100cm <i>Back-lighted panel covered with synthetic glossy leather. L.120xP.8 H.100cm</i> | € 505,00 | 9 | |
| 3P1R/NEPIT | Pannello retroilluminato in nobilitato opaco con inserto in Eco-pelle opaca. L.120xP.8 H.210cm <i>Back-lighted panel in matt chipboard with inserts covered with synthetic matt leather. L.120xP.8 H.210cm</i> | € 780,00 | 7 |  |
| 3P1R/NEPLIT | Pannello retroilluminato in nobilitato opaco con inserto in Eco-pelle lucida. L.120xP.8 H.210cm <i>Back-lighted panel in matt chipboard with inserts covered with synthetic glossy leather. L.120xP.8 H.210cm</i> | € 810,00 | 7 | |
| 3P1R/LEPIT | Pannello retroilluminato in nobilitato verniciato lucido (BIANCO/NERO) con inserto in Eco-pelle opaca. L.120xP.8 H.210cm <i>Back-lighted panel in glossy chipboard (WHITE/BLACK) with inserts covered with synthetic matt leather. L.120xP.8 H.210cm</i> | € 855,00 | 7 | |
| 3P1R/LEPLIT | Pannello retroilluminato in nobilitato verniciato lucido (BIANCO/NERO) con inserto in Eco-pelle lucida. L.120xP.8 H.210cm <i>Back-lighted panel in glossy chipboard (WHITE/BLACK) with inserts covered with synthetic glossy leather. L.120xP.8 H.210cm</i> | € 885,00 | 7 | |
| 3P2R/NEPIT | Pannello retroilluminato in nobilitato opaco con inserto in Eco-pelle opaca. L.120xP.8 H.100cm <i>Back-lighted panel in matt chipboard with inserts covered with synthetic matt leather. L.120xP.8 H.100cm</i> | € 465,00 | 7 | |
| 3P2R/NEPLIT | Pannello retroilluminato in nobilitato opaco con inserto in Eco-pelle lucida. L.120xP.8 H.100cm <i>Back-lighted panel in matt chipboard with inserts covered with synthetic glossy leather. L.120xP.8 H.100cm</i> | € 495,00 | 7 |  |
| 3P2R/LEPIT | Pannello retroilluminato in nobilitato verniciato lucido (BIANCO/NERO) con inserto in Eco-pelle opaca. L.120xP.8 H.100cm <i>Back-lighted panel in glossy chipboard (WHITE/BLACK) with inserts covered with synthetic matt leather. L.120xP.8 H.100cm</i> | € 500,00 | 7 | |
| 3P2R/LEPLIT | Pannello retroilluminato in nobilitato verniciato lucido (BIANCO/NERO) con inserto in Eco-pelle lucida. L.120xP.8 H.100cm <i>Back-lighted panel in glossy chipboard (WHITE/BLACK) with inserts covered with synthetic glossy leather. L.120xP.8 H.100cm</i> | € 530,00 | 7 | |
| ACCESSORI - CASSETTIERE <i>ACCESORIES - DRAWERS</i> | | | | |
| 3CA/NN | Cassetiera struttura e frontale in nobilitato opaco - cassetto con ruote e due maniglie. L.120xP.45 H.40cm <i>Chest of drawer structure and front in matt chipboard - drawer with wheels and 2 handles. L.120xP.45 H.40cm</i> | € 315,00 | 7 |  |
| 3CA/LN | Cassetiera struttura in nobilitato verniciato lucido (BIANCO/NERO) e frontale in nobilitato opaco - cassetto con ruote e due maniglie. L.120xP.45 H.40cm <i>Chest of drawer structure in glossy chipboard (WHITE/BLACK) and front in matt chipboard - drawer with wheels and 2 handles. L.120xP.45 H.40cm</i> | € 352,00 | 7 | |

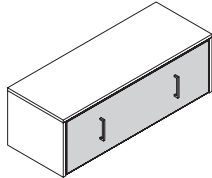
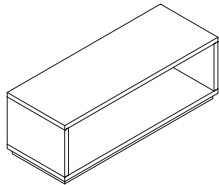
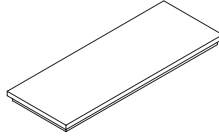
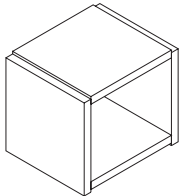
| CODICE <i>CODE</i> | DESCRIZIONE <i>DESCRIPTION</i> | PREZZO <i>PRICE</i> | PAG. <i>PAGE</i> | |
|--|--|-------------------------------|----------------------------|---|
| 3CA/LL | Cassettiera struttura e frontale in nobilitato verniciato lucido (BIANCO/NERO)- cassetto con ruote e due maniglie. L.120xP.45 H.40cm <i>Chest of drawer structure and front in glossy chipboard (WHITE/BLACK) - drawer with wheels and 2 handles. L. 120xP.45 H.40cm</i> | € 370,00 | 7 |  |
| 3CA/NEP | Cassettiera struttura in nobilitato opaco e frontale in Eco-pelle opaca - cassetto con ruote e due maniglie. L.120xP.45 H.40cm <i>Chest of drawer structure in matt chipboard and front covered with synthetic matt leather - drawer with wheels and 2 handles. L. 120xP.45 H.40cm</i> | € 375,00 | 7 | |
| 3CA/NEPL | Cassettiera struttura in nobilitato opaco e frontale in Eco-pelle lucida - cassetto con ruote e due maniglie. L.120xP.45 H.40cm <i>Chest of drawer structure in matt chipboard and front covered with synthetic glossy leather - drawer with wheels and 2 handles. L. 120xP.45 H.40cm</i> | € 385,00 | 7 | |
| 3CA/LEP | Cassettiera struttura in nobilitato verniciato lucido (BIANCO/NERO) e frontale in Eco-pelle opaca - cassetto con ruote e due maniglie. L.120xP.45 H.40cm <i>Chest of drawer structure in glossy chipboard (WHITE/BLACK) and front covered with synthetic matt leather - drawer with wheels and 2 handles. L. 120xP.45 H.40cm</i> | € 421,00 | 7 | |
| 3CA/LEPL | Cassettiera struttura in nobilitato verniciato lucido (BIANCO/NERO) e frontale in Eco-pelle lucida - cassetto con ruote e due maniglie. L.120xP.45 H.40cm <i>Chest of drawer structure in glossy chipboard (WHITE/BLACK) and front covered with synthetic glossy leather - drawer with wheels and 2 handles. L. 120xP.45 H.40cm</i> | € 431,00 | 7 | |
| 3CA/NST | Cassettiera struttura in nobilitato opaco e frontale in laminato di vera pietra - cassetto con ruote e due maniglie. L.120xP.45 H.40cm <i>Chest of drawer structure in matt chipboard and front in real stone veneer - drawer with wheels and 2 handles. L. 120xP.45 H.40cm</i> | € 445,00 | 7 | |
| 3CA/LST | Cassettiera struttura in nobilitato verniciato lucido (BIANCO/NERO) e frontale in laminato di vera pietra - cassetto con ruote e due maniglie. L.120xP.45 H.40cm <i>Chest of drawer structure in glossy chipboard (WHITE/BLACK) and front in real stone veneer - drawer with wheels and 2 handles. L. 120xP.45 H.40cm</i> | € 491,00 | 7 | |
| ANELLI E PEDANE <i>DISPLAY RINGS AND PLATFORMS</i> | | | | |
| 3A/N | Anello struttura in nobilitato opaco, rialzata con zoccolo. L.120xP.45 H.40cm <i>Display ring structure in matt chipboard, raised with baseboard. L. 120xP.45 H.40cm</i> | € 157,00 | 7 |  |
| 3A/L | Anello struttura in nobilitato verniciato lucido (BIANCO/NERO), rialzata con zoccolo. L.120xP.45 H.40cm <i>Display ring structure in glossy chipboard (WHITE/BLACK), raised with baseboard. L. 120xP.45 H.40cm</i> | € 229,00 | 7 | |
| 3PE/N | Pedana in nobilitato opaco - rialzata con zoccolo. L.120xP.45 H.40cm <i>Display platform in matt chipboard, raised with baseboard. L. 120xP.45 H.40cm</i> | € 85,00 | 7 |  |
| 3PE/L | Pedana in nobilitato verniciato lucido (BIANCO/NERO) - rialzata con zoccolo. L.120xP.45 H.40cm <i>Display platform in glossy chipboard (WHITE/BLACK), raised with baseboard. L. 120xP.45 H.40cm</i> | € 103,00 | 7 | |
| MODULI SOVRAPPONIBILI <i>STACKABLE ELEMENTS</i> | | | | |
| 3C18/N | Cubo in nobilitato opaco sp.18mm. L.42xP.40 H.36cm <i>Display cube in matt chipboard sp.18mm. L.42xP.40 H.36cm</i> | € 59,00 | 10 |  |
| 3C36/N | Cubo in nobilitato opaco sp.36mm. L.42xP.40 H.36cm <i>Display cube in matt chipboard sp.36mm. L.42xP.40 H.36cm</i> | € 105,00 | 10 | |
| 3C18/L | Cubo in nobilitato verniciato lucido (BIANCO/NERO) sp.18mm. L.42xP.40 H.36cm <i>Display cube in glossy chipboard (WHITE/BLACK) sp.18mm. L.42xP.40 H.36cm</i> | € 69,00 | 10 | |
| 3C30/L | Cubo in nobilitato verniciato lucido (BIANCO/NERO) sp.30mm. L.42xP.40 H.36cm <i>Display cube in glossy chipboard (WHITE/BLACK) sp.30mm. L.42xP.40 H.36cm</i> | € 98,00 | 10 | |

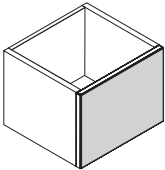
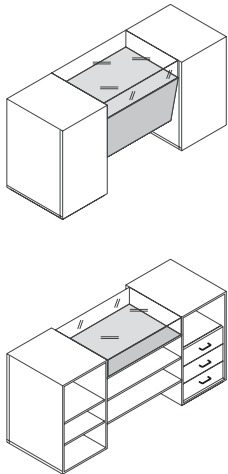
| CODICE <i>CODE</i> | DESCRIZIONE <i>DESCRIPTION</i> | PREZZO <i>PRICE</i> | PAG. <i>PAGE</i> | |
|---|--|-------------------------------|----------------------------|---|
| 3CAS/N | Cassetto struttura in nobilitato opaco e frontale in nobilitato opaco. L.35xP.37 H.27cm <i>Drawer structure in matt chipboard and front in matt chipboard. L.35xP.37 H.27cm</i> | € 52,00 | 10 |  |
| 3CAS/L | Cassetto struttura in nobilitato opaco e frontale in nobilitato verniciato lucido (BIANCO/NERO). L.35xP.37 H.27cm <i>Drawer structure in matt chipboard and front in glossy chipboard (WHITE/BLACK). L.35xP.37 H.27cm</i> | € 60,00 | 10 | |
| 3CAS/EP | Cassetto struttura in nobilitato opaco e frontale rivestito in Eco-pelle opaca. L.35xP.37 H.27cm <i>Drawer structure in matt chipboard and front covered with synthetic matt leather. L.35xP.37 H.27cm</i> | € 75,00 | 10 | |
| 3CAS/EPL | Cassetto struttura in nobilitato opaco e frontale rivestito in Eco-pelle lucida. L.35xP.37 H.27cm <i>Drawer structure in matt chipboard and front covered with synthetic glossy leather. L.35xP.37 H.27cm</i> | € 83,00 | 10 | |
| 3CAS/ST | Cassetto struttura in nobilitato opaco e frontale rin laminato di vera pietra. L.35xP.37 H.27cm <i>Drawer structure in matt chipboard and front in real stone veneer. L.35xP.37 H.27cm</i> | € 95,00 | 10 | |
| BANCHI CASSA <i>CASH COUNTERS</i> | | | | |
| 3BC1/NN | Banco cassa elementi laterali e elemento centrale in nobilitato opaco - teca in vetro - 6 vani - 3 cassetti. L.220xP70 H.102cm <i>Cash counter lateral units and middle unit in matt chipboard - glass showcase - 6 compartments - 3 drawers. L.220xP.70 H.102cm</i> | € 1.535,00 | 11 |  |
| 3BC1/NL | Banco cassa elementi laterali in nobilitato opaco e elemento centrale in nobilitato verniciato lucido (BIANCO/NERO) - teca in vetro - 6 vani - 3 cassetti. L.220xP70 H.102cm <i>Cash counter lateral units in matt chipboard and middle unit in glossy chipboard (WHITE/BLACK) - glass showcase - 6 compartments - 3 drawers. L.220xP.70 H.102cm</i> | € 1.690,00 | 11 | |
| 3BC1/LN | Banco cassa elementi laterali in nobilitato verniciato lucido (BIANCO/NERO) e elemento centrale in nobilitato opaco- teca in vetro - 6 vani - 3 cassetti. L.220xP70 H.102cm <i>Cash counter lateral units in glossy chipboard (WHITE/BLACK) and middle unit in matt chipboard - glass showcase 6 compartments - 3 drawers. L.220xP.70 H.102cm</i> | € 1.835,00 | 11 | |
| 3BC1/NEP | Banco cassa elementi laterali in nobilitato opaco e elemento centrale rivestito in Eco-pelle opaca - teca in vetro - 6 vani - 3 cassetti. L.220xP70 H.102cm <i>Cash counter lateral units in matt chipboard and middle unit covered with synthetic matt leather - glass showcase - 6 compartments - 3 drawers. L.220xP.70 H.102cm</i> | € 1.705,00 | 11 | |
| 3BC1/NEPL | Banco cassa elementi laterali in nobilitato opaco e elemento centrale rivestito in Eco-pelle lucida - teca in vetro - 6 vani - 3 cassetti. L.220xP70 H.102cm <i>Cash counter lateral units in matt chipboard and middle unit covered with synthetic glossy leather - glass showcase - 6 compartments - 3 drawers. L.220xP.70 H.102cm</i> | € 1.745,00 | 11 | |
| 3BC1/LL | Banco cassa elementi laterali e elemento centrale in nobilitato verniciato lucido (BIANCO/NERO) - teca in vetro - 6 vani - 3 cassetti. L.220xP70 H.102cm <i>Cash counter lateral units and middle unit in glossy chipboard (WHITE/BLACK) - glass showcase - 6 compartments - 3 drawers. L.220xP.70 H.102cm</i> | € 1.990,00 | 11 | |
| 3BC1/LEP | Banco cassa elementi laterali in nobilitato verniciato lucido (BIANCO/NERO) e elemento centrale rivestito in Eco-pelle opaca - teca in vetro - 6 vani - 3 cassetti. L.220xP70 H.102cm <i>Cash counter lateral units in glossy (WHITE/BLACK) chipboard and middle unit covered with synthetic matt leather - glass showcase - 6 compartments - 3 drawers. L.220xP.70 H.102cm</i> | € 2.005,00 | 11 | |

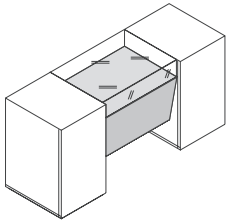
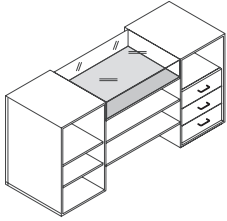
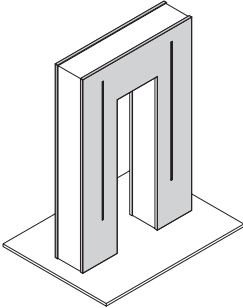
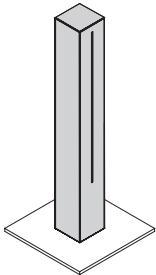
| CODICE <i>CODE</i> | DESCRIZIONE <i>DESCRIPTION</i> | PREZZO <i>PRICE</i> | PAG. <i>PAGE</i> | |
|--|--|-------------------------------|----------------------------|--|
| 3BC1/LEPL | Banco cassa elementi laterali in nobilitato verniciato lucido (BIANCO/NERO) e elemento centrale rivestito in Eco-pelle lucida - teca in vetro - 6 vani - 3 cassetti. L.220xP.70 H.102cm <i>Cash counter lateral units in glossy (WHITE/BLACK) chipboard and middle unit covered with synthetic glossy leather - glass showcase - 6 compartments - 3 drawers. L.220xP.70 H.102cm</i> | € 2.045,00 | 11 |   |
| 3BC1/NST | Banco cassa elementi laterali in nobilitato opaco e elemento centrale in laminato di vera pietra - teca in vetro - 6 vani - 3 cassetti. L.220xP.70 H.102cm <i>Cash counter lateral units in matt chipboard and middle unit in real stone veneer - glass showcase - 6 compartments - 3 drawers. L.220xP.70 H.102cm</i> | € 1.950,00 | 11 | |
| 3BC1/LST | Banco cassa elementi laterali in nobilitato verniciato lucido (BIANCO/NERO) e elemento centrale in laminato di vera pietra- teca in vetro - 6 vani - 3 cassetti. L.220xP.70 H.102cm <i>Cash counter lateral units in glossy chipboard (WHITE/BLACK) and middle unit in real stone veneer - glass showcase - 6 compartments - 3 drawers. L.220xP.70 H.102cm</i> | € 2.250,00 | 11 | |
| ISOLA AUTOPORTANTE <i>FREE STANDING UNIT</i> | | | | |
| 3IS/N | Gondola, base e struttura in nobilitato opaco, frontali in nobilitato opaco. L.120xP.90 H.160cm <i>Freestanding unit, base and structure in matt chipboard, front in matt chipboard. L.120xP.90 H.160cm</i> | € 700,00 | 12 |  |
| 3IS/NL | Gondola, base e struttura in nobilitato opaco, frontali in nobilitato verniciato lucido (BIANCO/NERO). L.120xP.90 H.160cm <i>Freestanding unit, base and structure in matt chipboard, front in glossy chipboard (WHITE/BLACK). L.120xP.90 H.160cm</i> | € 788,00 | 12 | |
| 3IS/EP | Gondola, base e struttura in nobilitato opaco, frontali rivestiti in Eco-pelle opaca. L.120xP.90 H.160cm <i>Freestanding unit, base and structure in matt chipboard, front covered with synthetic matt leather. L.120xP.90 H.160cm</i> | € 910,00 | 12 | |
| 3IS/EPL | Gondola, base e struttura in nobilitato opaco, frontali rivestiti in Eco-pelle lucida. L.120xP.90 H.160cm <i>Freestanding unit, base and structure in matt chipboard, front covered with synthetic glossy leather. L.120xP.90 H.160cm</i> | € 940,00 | 12 | |
| 3TO/N | Totem base in nobilitato opaco, totem in nobilitato opaco. L.60xP.60 H.150cm <i>Totem unit base in matt chipboard, totem in matt chipboard. L.60xP.60 H.150cm</i> | € 325,00 | 12 | |
| 3TO/L | Totem base in nobilitato opaco, totem in nobilitato verniciato lucido (BIANCO/NERO). L.60xP.60 H.150cm <i>Totem unit base in matt chipboard, totem in glossy chipboard (WHITE/BLACK). L.60xP.60 H.150cm</i> | € 355,00 | 12 |  |
| 3TO/EP | Totem base in nobilitato opaco, totem rivestito in Eco-pelle opaca. L.60xP.60 H.150cm <i>Totem unit base in matt chipboard, totem covered with synthetic matt leather. L.60xP.60 H.150cm</i> | € 435,00 | 12 | |
| 3TO/EPL | Totem base in nobilitato opaco, totem rivestito in Eco-pelle lucida. L.60xP.60 H.150cm <i>Totem unit base in matt chipboard, totem covered with synthetic glossy leather. L.60xP.60 H.150cm</i> | € 462,00 | 12 | |



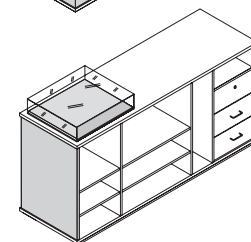
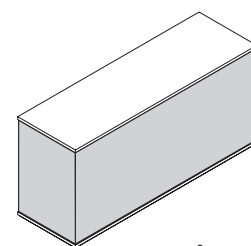
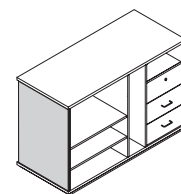
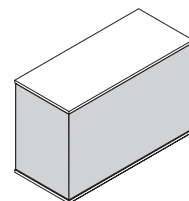

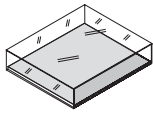
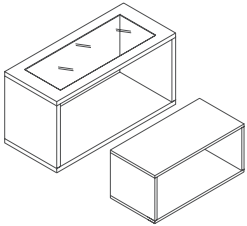
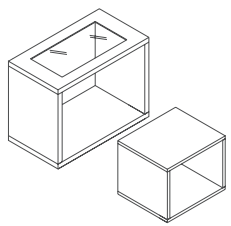
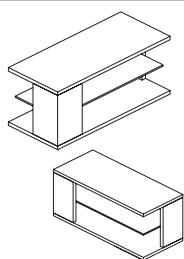

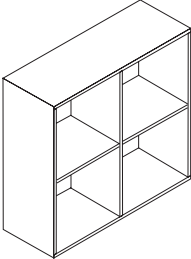
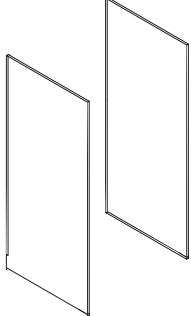
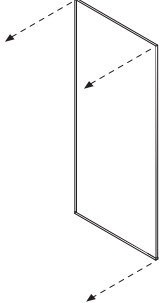
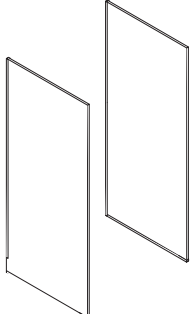
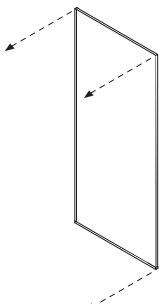
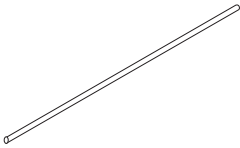

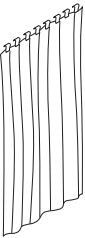
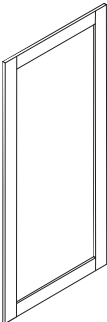
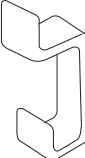
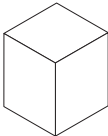
| CODICE <i>CODE</i> | DESCRIZIONE <i>DESCRIPTION</i> | PREZZO <i>PRICE</i> | PAG. <i>PAGE</i> |
|---|--|-------------------------------|----------------------------|
| BANCO CASSA <i>CASH COUNTER</i> | | | |
| 3BC2/N | Banco cassa small struttura interna in nobilitato opaco, frontale e laterali in nobilitato opaco. Top e fondo in nobilitato opaco - 5 vani - 3 cassetti. L.162xP.70 H.102cm <i>Small cash counter inner structure in matt chipboard, front and laterals in matt chipboard. Top and bottom in matt chipboard - 5 compartments - 3 drawers. L.162xP.70 H.102cm</i> | € 1.025,00 | 13 |
| 3BC2/L | Banco cassa small struttura interna in nobilitato opaco, frontale e laterali in nobilitato verniciato lucido (BIANCO/NERO). Top e fondo in nobilitato lucido - 5 vani - 3 cassetti. L.162xP.70 H.102cm <i>Small cash counter inner structure in matt chipboard, front and laterals in glossy chipboard (WHITE/BLACK). Top and bottom in glossy chipboard - 5 compartments - 3 drawers. L.162xP.70 H.102cm</i> | € 1.125,00 | 13 |
| 3BC2/NL | Banco cassa small struttura interna in nobilitato opaco, frontale e laterali in nobilitato verniciato lucido (BIANCO/NERO). Top e fondo in nobilitato opaco - 5 vani - 3 cassetti. L.162xP.70 H.102cm <i>Small cash counter inner structure in matt chipboard, front and lateral in glossy chipboard (WHITE/BLACK). Top and bottom in matt chipboard - 5 compartments - 3 drawers. L.162xP.70 H.102cm</i> | € 1.075,00 | 13 |
| 3BC2/EP | Banco cassa small struttura in nobilitato opaco, frontale e laterali rivestiti in Eco-pelle opaca. Top e fondo in nobilitato opaco - 5 vani - 3 cassetti. L.162xP.70 H.102cm <i>Small cash counter inner structure in matt chipboard, front and laterals covered with synthetic matt leather. Top and bottom in matt chipboard - 5 compartments - 3 drawers. L.162xP.70 H.102cm</i> | € 1.330,00 | 13 |
| 3BC2/EPL | Banco cassa small struttura in nobilitato opaco, frontale e laterali rivestiti in Eco-pelle lucida. Top e fondo in nobilitato opaco - 5 vani - 3 cassetti. L.162xP.70 H.102cm <i>Small cash counter inner structure in matt chipboard, front and laterals covered with synthetic glossy leather. Top and bottom in matt chipboard - 5 compartments - 3 drawers. L.162xP.70 H.102cm</i> | € 1.360,00 | 13 |
| 3BC2/ST | Banco cassa small struttura in nobilitato opaco, frontale e laterali in laminato di vera pietra. Top e fondo in nobilitato opaco - 5 vani - 3 cassetti. L.162xP.70 H.102cm <i>Small cash counter inner structure in matt chipboard, front and laterals in real stone veneer. Top and bottom in matt chipboard - 5 compartments - 3 drawers. L.162xP.70 H.102cm</i> | € 1.800,00 | 13 |
| BANCO CASSA LARGE <i>CASH COUNTER</i> | | | |
| 3BC3/N | Banco cassa large struttura interna in nobilitato opaco, frontale e laterali in nobilitato opaco. Top e fondo in nobilitato opaco - 8 vani - 3 cassetti. L.220xP.70 H.102cm <i>Large cash counter inner structure in matt chipboard, front and laterals in matt chipboard. Top and bottom in matt chipboard - 8 compartments - 3 drawers. L.220xP.70 H.102cm</i> | € 1.185,00 | 13 |
| 3BC3/L | Banco cassa large struttura interna in nobilitato opaco, frontale e laterali in nobilitato verniciato lucido (BIANCO/NERO). Top e fondo in nobilitato lucido - 8 vani - 3 cassetti. L.220xP.70 H.102cm <i>Large cash counter inner structure in matt chipboard, front and laterals in glossy chipboard (WHITE/BLACK). Top and bottom in glossy chipboard - 8 compartments - 3 drawers. L.220xP.70 H.102cm</i> | € 1.370,00 | 13 |
| 3BC3/NL | Banco cassa large struttura interna in nobilitato opaco, frontale e laterali in nobilitato verniciato lucido (BIANCO/NERO). Top e fondo in nobilitato opaco - 8 vani - 3 cassetti. L.220xP.70 H.102cm <i>Large cash counter inner structure in matt chipboard, front and lateral in glossy chipboard (WHITE/BLACK). Top and bottom in matt chipboard - 8 compartments - 3 drawers. L.220xP.70 H.102cm</i> | € 1.280,00 | 13 |
| 3BC3/EP | Banco cassa large struttura in nobilitato opaco, frontale e laterali rivestiti in Eco-pelle opaca. Top e fondo in nobilitato opaco - 8 vani - 3 cassetti. L.220xP.70 H.102cm <i>Large cash counter inner structure in matt chipboard, front and laterals covered with synthetic matt leather. Top and bottom in matt chipboard - 8 compartments - 3 drawers. L.220xP.70 H.102cm</i> | € 1.535,00 | 13 |

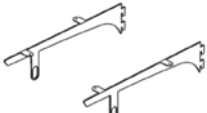



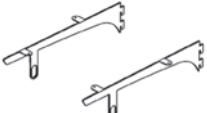

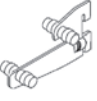
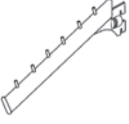
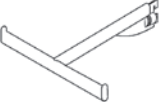



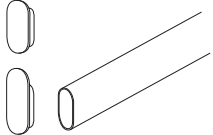
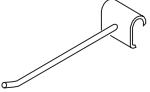

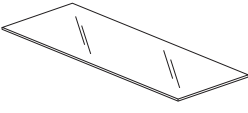

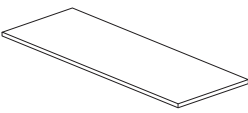

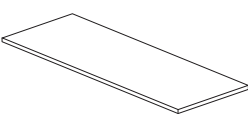
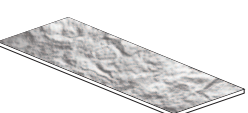

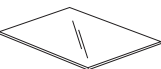

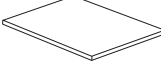
| CODICE <i>CODE</i> | DESCRIZIONE <i>DESCRIPTION</i> | PREZZO <i>PRICE</i> | PAG. <i>PAGE</i> | |
|---|---|-------------------------------|----------------------------|---|
| 3BC3/EPL | Banco cassa large struttura in nobilitato opaco, frontale e laterali rivestiti in Eco-pelle lucida. Top e fondo in nobilitato opaco - 8 vani - 3 cassetti. L.220xP.70 H.102cm <i>Large cash counter inner structure in matt chipboard, front and laterals covered with synthetic glossy leather. Top and bottom in matt chipboard - 8 compartments - 3 drawers. L.220xP.70 H.102cm</i> | € 1.575,00 | 13 | |
| 3BC3/ST | Banco cassa large struttura in nobilitato opaco, frontale e laterali in laminato di vera pietra. Top e fondo in nobilitato opaco - 8 vani - 3 cassetti. L.220xP.70 H.102cm <i>Large cash counter inner structure in matt chipboard, front and laterals in real stone veneer. Top and bottom in matt chipboard - 8 compartments - 3 drawers. L.220xP.70 H.102cm</i> | € 2.055,00 | 13 | |
| TECA IN VETRO <i>GLASS SHOWCASE</i> | | | | |
| 3TC/N | Teca in vetro con base in nobilitato opaco L.60xP.70 H.15cm <i>Glass showcase with base in matt chipboard L.60xP.70 H.15cm</i> | € 257,00 | 13 |  |
| 3TC/L | Teca in vetro con base in nobilitato verniciato lucido (BIANCO/NERO) L.60xP.70 H.15cm <i>Glass showcase with base in glossy chipboard (WHITE/BLACK) L.60xP.70 H.15cm</i> | € 267,00 | 13 | |
| 3TC/EP | Teca in vetro con base rivestita in Eco-pelle opaca L.60xP.70 H.15cm <i>Glass showcase with base covered with synthetic matt leather L.60xP.70 H.15cm</i> | € 287,00 | 13 | |
| 3TC/EPL | Teca in vetro con base rivestita in Eco-pelle lucida L.60xP.70 H.15cm <i>Glass showcase with base covered with synthetic glossy leather L.60xP.70 H.15cm</i> | € 297,00 | 13 | |
| 3TC/ST | Teca in vetro con base in laminato di vera pietra L.60xP.70 H.15cm <i>Glass showcase with base in real stone veneer L.60xP.70 H.15cm</i> | € 355,00 | 13 | |
| TAVOLI <i>TABLES</i> | | | | |
| 3TAVL/N | Tavolo large in nobilitato opaco, vetro ad incastro L.160xP.70 H.85cm + vano estraibile in nobilitato opaco L.120xP.60 H.56cm <i>Large table in matt chipboard, with set glass L.160xP.70 H.85cm + removable compartment in matt chipboard L.120xP.60 H.56cm</i> | € 785,00 | 14 |  |
| 3TAVL/L | Tavolo large in nobilitato verniciato lucido (BIANCO/NERO), vetro ad incastro L.160xP.70 H.85cm + vano estraibile in nobilitato verniciato lucido (BIANCO/NERO) L.120xP.60 H.56cm <i>Large table in glossy chipboard (WHITE/BLACK), with set glass L.160xP.70 H.85cm + removable compartment in glossy chipboard (WHITE/BLACK) L.120xP.60 H.56cm</i> | € 936,00 | 14 | |
| 3TAVS/N | Tavolo small in nobilitato opaco, vetro ad incastro L.110xP.70 H.85cm + vano estraibile in nobilitato opaco L.70xP.50 H.56cm <i>Small table in matt chipboard, with set glass L.110xP.70 H.85cm + removable compartment in matt chipboard L.70xP.50 H.56cm</i> | € 677,00 | 14 |  |
| 3TAVS/L | Tavolo small in nobilitato verniciato lucido (BIANCO/NERO), vetro ad incastro L.110xP.70 H.85cm + vano estraibile in nobilitato verniciato lucido (BIANCO/NERO) L.70xP.50 H.56cm <i>Small table in glossy chipboard (WHITE/BLACK), with set glass L.110xP.70 H.85cm + removable compartment in glossy chipboard (WHITE/BLACK) L.70xP.50 H.56cm</i> | € 777,00 | 14 | |
| 3TA/N | Tavolo in nobilitato opaco. L.160xP.70 H.85cm <i>Table in matt chipboard. L.160xP.70 H.85cm</i> | € 635,00 | 15 |  |
| 3TA/L | Tavolo in nobilitato verniciato lucido (BIANCO/NERO). L.160xP.70 H.85cm <i>Table in glossy chipboard (WHITE/BLACK). L.160xP.70 H.85cm</i> | € 815,00 | 15 | |

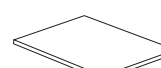
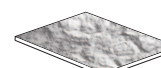
| CODICE <i>CODE</i> | DESCRIZIONE <i>DESCRIPTION</i> | PREZZO <i>PRICE</i> | PAG. <i>PAGE</i> | |
|---|--|-------------------------------|----------------------------|---|
| MODULO RETRO CASSA <i>BACK CASH COUNTER ELEMENT</i> | | | | |
| 3RC/N | Modulo retro cassa in nobilitato opaco L.100xP.40 H.100cm <i>Back counter unit in matt chipboard L.100xP.40 H.100cm</i> | € 260,00 | 15 |  |
| 3RC/NL | Modulo retro cassa in nobilitato verniciato lucido (BIANCO/NERO) (solo esterno) L.100xP.40 H.100cm <i>Back counter unit in glossy chipboard (WHITE/BLACK) (only external) L.100xP.40 H.100cm</i> | € 315,00 | 15 | |
| CAMERINI <i>CHANGING ROOMS</i> | | | | |
| 3CAM1/N | Camerino, coppia pannelli in nobilitato opaco completo di profili in metallo per fissaggio a parete e a pavimento. L.100xH.220cm <i>Changing room, pair of panels in matt chipboard, complete with wall and floor fixing. L.100xH.220cm</i> | € 395,00 | 16 |  |
| 3CAM2/N | Modulo aggiuntivo per camerino comprendente un pannello in nobilitato opaco, completo di profili in metallo per fissaggio a parete e a pavimento. L.100xH.220cm <i>Additional panel for changing room in matt chipboard, complete with wall and floor fixing. L.100xH.220cm</i> | € 195,00 | 16 |  |
| 3CAM1/L | Camerino, coppia pannelli in nobilitato verniciato lucido (BIANCO/NERO) completo di profili in metallo per fissaggio a parete e a pavimento. L.100xH.220cm <i>Changing room, pair of panels in glossy chipboard (WHITE/BLACK), complete with wall and floor fixing. L.100xH.220cm</i> | € 495,00 | 16 |  |
| 3CAM2/L | Modulo aggiuntivo per camerino comprendente un pannello in nobilitato verniciato lucido (BIANCO/NERO), completo di profili in metallo per fissaggio a parete e a pavimento. L.100xH.220cm <i>Additional panel for changing room in glossy chipboard (WHITE/BLACK), complete with wall and floor fixing. L.100xH.220cm</i> | € 265,00 | 16 |  |
| 3CAMTUB | Tubo camerino in metallo con fascetta frontale di copertura. <i>Metal tube for changing room with covering panel.</i> | € 30,00 | 16 |  |

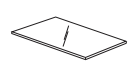
| CODICE <i>CODE</i> | DESCRIZIONE <i>DESCRIPTION</i> | PREZZO <i>PRICE</i> | PAG. <i>PAGE</i> | |
|------------------------------|--|-------------------------------|----------------------------|---|
| 3TEV | Tenda camerino in tessuto <i>Fabric curtain for changing room</i> | € 240,00 | 16 |  |
| 3MRR/N | Specchio - cornice in nobilitato opaco. L.85xH.205cm <i>Mirror - frame in matt chipboard. L.85xH.205cm</i> | € 310,00 | 16 | |
| 3MRR/L | Specchio - cornice in nobilitato verniciato lucido (BIANCO/NERO) L.85xH.205cm <i>Mirror - frame in glossy chipboard (WHITE/BLACK) L.85xH.205cm</i> | € 365,00 | 16 |  |
| 3MRR/EP | Specchio - cornice rivestita in Eco-pelle opaca. L.85xH.205cm <i>Mirror - frame covered with synthetic matt leather. L.85xH.205cm</i> | € 451,00 | 16 | |
| 3MRR/EPL | Specchio - cornice rivestita in Eco-pelle lucida. L.85xH.205cm <i>Mirror - frame covered with synthetic glossy leather. L.85xH.205cm</i> | € 466,00 | 16 | |
| 3GA | n.1 Gancio appenderia in metallo <i>n.1 metal hanger</i> | € 32,00 | 16 |  |
| 3POU/N | Seduta-pouf in nobilitato opaco. L.45xP.45 H.45cm <i>Pouf in matt chipboard. L.45xP.45 H.45cm</i> | € 98,00 | 16 | |
| 3POU/L | Seduta-pouf in nobilitato verniciato lucido (BIANCO/NERO). L.45xP.45 H.45cm <i>Pouf in glossy chipboard (WHITE/BLACK). L.45xP.45 H.45cm</i> | € 118,00 | 16 | |
| 3POU/EP | Seduta-pouf rivestito in Eco-pelle opaca. L.45xP.45 H.45cm <i>Pouf covered with synthetic matt leather. L.45xP.45 H.45cm</i> | € 180,00 | 16 | |
| 3POU/EPL | Seduta-pouf rivestito in Eco-pelle lucida. L.45xP.45 H.45cm <i>Pouf covered with synthetic glossy leather. L.45xP.45 H.45cm</i> | € 195,00 | 16 |  |

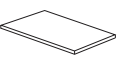
| CODICE <i>CODE</i> | DESCRIZIONE <i>DESCRIPTION</i> | PREZZO <i>PRICE</i> | PAG. <i>PAGE</i> | |
|---|---|-------------------------------|----------------------------|---|
| ACCESSORI <i>ACCESSORIES</i> | | | | |
| 3BAP  | Barra appenderia finitura cromo opaco. L.115cm <i>Crossbar in matt chrome finishing. L.115cm</i> | € 58,00 | 17 |  |
| 3RM/L  | Coppia staffe reggimensola per legno finitura cromo opaco. L.30cm <i>Pair of shelves holder for wood. In matt chrome finishing. L.30cm</i> | € 24,00 | 17 |  |
| 3MEBAP/L  | Coppia staffe reggimensola per legno e barra appenderia finitura cromo opaco. L.30cm <i>Pair of shelves holder for wood. With hanging bar hook. In matt chrome finishing. L.30cm</i> | € 33,00 | 17 |  |
| 3RMM/L  | Staffa singola per mensola media e piccola in legno finitura cromo opaco. L.20cm Con sistema antisbandieramento <i>Single shelf holder in matt chrome finishing. L.20cm With anti-swing system</i> | € 24,00 | 17 |  |
| 3RM/V  | Coppia staffe reggimensola per vetro finitura cromo opaco. L.30cm <i>Pair of shelf brackets for 8mm glass. In matt chrome finishing. L.30cm</i> | € 24,00 | 17 |  |
| 3MEBAP/V  | Coppia staffe reggimensola per vetro e barra appenderia finitura cromo opaco. L.30cm <i>Pair of glass shelf brackets. With hanging bar hook. In matt chrome finishing. L.30cm</i> | € 33,00 | 17 |  |
| 3RMM/V  | Staffa reggimensola per mensola in vetro media. Per vetro sp.8mm finitura cromo opaco. L.40xP.35cm. Con sistema antisbandieramento <i>Single shelf holder (for medium shelf). For 8mm glass shelf. In matt chrome finishing. L.40xP.35cm. With anti-swing system</i> | € 48,00 | 17 |  |
| 3RMS/V  | Staffa reggimensola per mensola in vetro piccola. Per vetro sp.8mm finitura cromo opaco. L.10cm. Con sistema antisbandieramento <i>Single shelf holder (for small shelf). For 8mm glass shelf. In matt chrome finishing. L.10cm. With anti-swing system</i> | € 26,00 | 17 |  |
| 3APF  | Appendia frontale diritta finitura cromo opaco. L.30cm. Con sistema antisbandieramento <i>Straight frontal crossbar in matt chrome finishing. L.30cm. With anti-swing system</i> | € 24,00 | 17 |  |
| 3APFZ  | Appendia frontale inclinata finitura cromo opaco. L.38cm. Con sistema antisbandieramento <i>Tilted frontal crossbar in matt chrome finishing, L.38cm. With anti-swing system</i> | € 52,00 | 17 |  |
| 3BAP2  | Barra appenderia piccola finitura cromo opaco. L.40xP.35cm. Con sistema antisbandieramento <i>Small crossbar in matt chrome finishing. L.40xP.35cm. With anti-swing system</i> | € 56,00 | 17 |  |
| 3RT  | Supporto reggitubo per tubo ovale 30x15mm finitura cromo opaco <i>Holder for oval tube 30x15mm in matt chrome finishing</i> | € 17,00 | 17 |  |

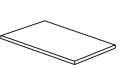
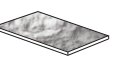
| CODICE <i>CODE</i> | DESCRIZIONE <i>DESCRIPTION</i> | PREZZO <i>PRICE</i> | PAG. <i>PAGE</i> | |
|---|--|-------------------------------|----------------------------|---|
| ACCESSORI <i>ACCESSORIES</i> | | | | |
| 3TUB  | Tubo ovale 30x15mm finitura cromo opaco. Completo con tappi di chiusura. L.120cm <i>Oval tube 30x15mm in matt chrome finishing. Complete with closing claps.L.120cm</i> | € 25,00 | 17 |  |
| 3BLIST | Portablister per tubo ovale 30x15mm finitura cromo opaco. L.20cm <i>Blister holder for oval tube 30x15mm matt chrome finishing. L.20cm</i> | € 12,00 | 17 |  |
| 3ME/V  | Mensola in vetro temperato. L.115xP.40cm sp.8mm <i>Tempered glass shelf. L.115xP.40cm sp.8mm</i> | € 44,00 | 18 |  |
| 3ME/L  | Mensola in nobilitato verniciato lucido (BIANCO/NERO). L.115xP.40cm sp.18mm <i>Shelf in glossy chipboard (WHITE/BLACK). L.115xP.40cm sp.18mm</i> | € 55,00 | 18 |  |
| 3ME/N  | Mensola in nobilitato opaco. L.115xP.40cm sp.18mm <i>Shelf in matt chipboard. L.115xP.40cm sp.18mm</i> | € 39,00 | 18 |  |
| 3ME/ST | Mensola in laminato di vera pietra. L.115xP.40cm sp.18mm <i>Shelf in real stone veneer. L.115xP.40cm sp.18mm</i> | € 205,00 | 18 |  |
| 3MEM/V  | Mensola in vetro temperato. L.40xP.40cm sp.8mm <i>Tempered glass shelf. L.40xP.40cm sp.8mm</i> | € 24,00 | 18 |  |
| 3MEM/L  | Mensola in nobilitato verniciato lucido (BIANCO/NERO). L.55xP.40cm sp.18mm <i>Shelf in glossy chipboard (WHITE/BLACK). L.55xP.40cm sp.18mm</i> | € 40,00 | 18 |  |
| 3MEM/N  | Mensola in nobilitato opaco. L.55xP.40cm sp.18mm <i>Shelf in matt chipboard. L.55xP.40cm sp.18mm</i> | € 28,00 | 18 |  |
| 3MEM/ST | Mensola in laminato di vera pietra. L.55xP.40cm sp.18mm <i>Shelf in real stone veneer. L.55xP.40cm sp.18mm</i> | € 116,00 | 18 |  |
| 3MES/V  | Mensola in vetro temperato. L.40xP.20cm sp.8mm <i>Tempered glass shelf. L.40xP.20cm sp.8mm</i> | € 22,00 | 18 |  |
| 3MES/L  | Mensola in nobilitato verniciato lucido (BIANCO/NERO). L.40xP.20cm sp.18mm <i>Shelf in glossy chipboard (WHITE/BLACK). L.40xP.20cm sp.18mm</i> | € 30,00 | 18 |  |
| 3MES/N  | Mensola in nobilitato opaco. L.40xP.20cm sp.18mm <i>Shelf in matt chipboard. L.40xP.20cm sp.18mm</i> | € 21,00 | 18 |  |
| 3MES/ST | Mensola in laminato di vera pietra. L.40xP.20cm sp.18mm <i>Shelf in real stone veneer. L.40xP.20cm sp.18mm</i> | € 65,00 | 18 |  |

MADE IN ITALY



CONDIZIONI GENERALI DI VENDITA

- La merce viene controllata prima della spedizione. Il vettore è il solo responsabile di eventuali danni. Spetta al cliente controllare la merce all'atto del ritiro e contestare subito al vettore le eventuali avarie e mancanze. Reclami non relativi al trasporto devono essere presentati entro 8 giorni dalla data di ricevimento della merce. Dopo tale termine la merce si intende integralmente accettata.
- La Brugnotto shop interiors si riserva di apportare variazioni tecniche, dimensionali, estetiche a materiali e prodotti.
- Non verranno accettati resi di merce se non preventivamente autorizzati per iscritto da Brugnotto shop interiors. Il reso sarà sempre spedito alla nostra sede franco ogni spesa e adeguatamente imballato nella scatola originale. Imballaggi inadeguati che comportino danni all'articolo, autorizzeranno Brugnotto shop interiors ad addebitare il costo.
- Per qualsiasi controversia il Foro competente sarà quello di Treviso.

GENERAL TERMS OF SALE

- *The goods are checked before any shipment. The carrier is the one responsible for any damage. It's up to the customer to check the goods upon collection and contest immediately the carrier for any lacking or damage.*
- *Brugnotto shop interiors reserves the right to bring any technical, size and aesthetical modifications to the products.*
- *Returned good will not be accepted unless previously authorized by Brugnotto shop interiors in writing by written letter. Returned goods must always be sent to our main offices free of all charges and properly packaged in their original box. Improper boxing, resulting in damage to the item, will authorize Brugnotto shop interiors to charge its cost. The purchaser, under no circumstances, will have a claim on any type of compensation. Penalties may be taken into consideration only upon previous written agreements.*
- *Any dispute will be resolved at the place of jurisdiction of Treviso (Italy).*

BRUGNOTTO®
SHOP INTERIORS

Brugnotto s.r.l.
Via delle Industrie 10
31050 ZENSON DI PIAVE (TV)
Tel. +39 0421 344575 - Fax +39 0421 344226

www.shopinteriors.it
info@shopinteriors.it

